

# Linear Floor Former, Purus Drain, Micro Cement Floor Finish, Black Alu. Grid - Choice of Size

## Product Images

---

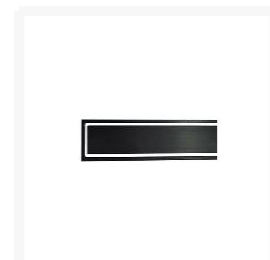

**Waste Options:**

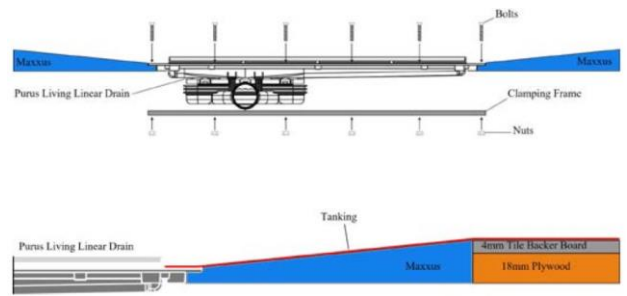
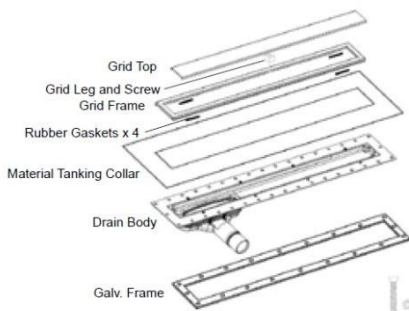
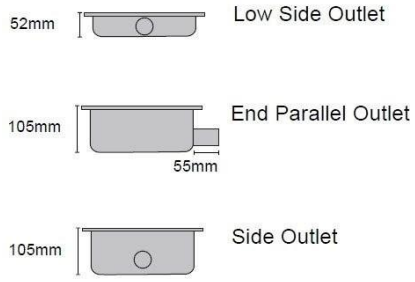

**MC988 - Wide**  
1200 x 900 x 22mm

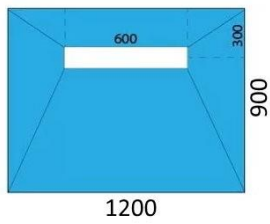

**MC984 - Long**  
1200 x 900 x 22mm

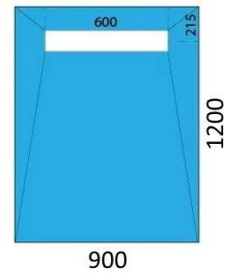

MC987

1200 x 1200 x 22mm

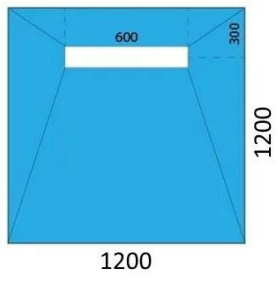

## Product Options

Maxxus Code / Former size / Purus Linear drain width (mm)

### MC988B / Wide 1200x900 / 600



Maxxus linear floor former. 1200mm wide x 900mm, 22mm thick. 600mm Purus Linear drain with a brushed black anodised aluminium Microcement grid, manufactured by Wetroom Innovations. Choice of three outlets, Low side, Side and End Parallel/side side outlet, for up to 72 litres/minute flow rate. Creates a 3mm upstand for use with microcement and resin floor finishes. Self-supporting 470kg load-bearing deck over 400mm joist centres.

### MC984B / Long 1200x900 / 600



Maxxus linear floor former. 1200mm long x 900mm, 22mm thick. 600mm Purus Linear drain with a brushed black anodised aluminium Microcement grid, manufactured by Wetroom Innovations. Choice of three outlets, Low side, Side and End Parallel/side side outlet, for up to 72 litres/minute flow rate. Creates a 3mm upstand for use with microcement and resin floor finishes. Self-supporting 470kg load-bearing deck over 400mm joist centres.

### MC987B / 1200x1200 / 600



Maxxus linear floor former. 1200x1200mm, 22mm thick. 600mm Purus Linear drain with a brushed black anodised aluminium Microcement grid, manufactured by Wetroom Innovations. Choice of three outlets, Low side, Side and End Parallel/side side outlet, for up to 72 litres/minute flow rate. Creates a 3mm upstand for use with microcement and resin flooring. Self-supporting 470kg load-bearing deck over 400mm joist centres.

### MC985B / 1400x900/ 800

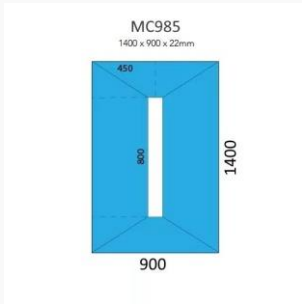

Maxxus linear floor former. 1400x900mm, 22mm thick. 800mm Purus Linear drain with a brushed black anodised aluminium Microcement grid, manufactured by Wetroom Innovations. Choice of three outlets, Low side, Side and End Parallel/side side outlet, for up to 72 litres/minute flow rate. Creates a 3mm upstand for use with microcement and resin flooring. Self-supporting 470kg load-bearing deck over 400mm joist centres.

### MC989B / 1500x900/ 600

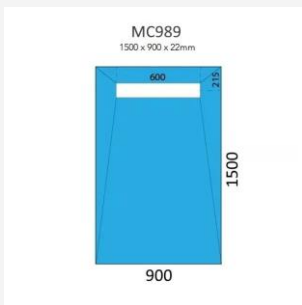

Maxxus linear floor former. 1500x900mm, 22mm thick. 600mm Purus Linear drain with a brushed black anodised aluminium Microcement grid, manufactured by Wetroom Innovations. Choice of three outlets, Low side, Side and End Parallel/side side outlet, for up to 72 litres/minute flow rate. Creates a 3mm upstand for use with microcement and resin flooring. Self-supporting 470kg load-bearing deck over 400mm joist centres.

### MC986B / 1600x900/ 800

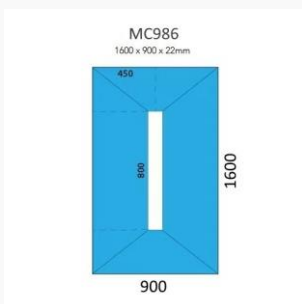

Maxxus linear floor former. 1600x900mm, 22mm thick. 800mm Purus Linear drain with a brushed black anodised aluminium Microcement grid, manufactured by Wetroom Innovations. Choice of three outlets, Low side, Side and End Parallel/side side outlet, for up to 72 litres/minute flow rate. Creates a 3mm upstand for use with microcement and resin flooring. Self-supporting 470kg load-bearing deck over 400mm joist centres.

## Purus horizontal waste outlet



### 52mm Low (Side Outlet)

PurusLivinglineardrainwithalowhorizontalsideoutlet. Gravity wastewithasprungNoodtrap,anoodourwaste. 52mm depth with a 32 l/m flow rate.



### 105mm (Side Outlet)

PurusLivinglineardrainwithahorizontalsideoutlet.Gravity waste withasprungNoodtrap,anoodourwaste.105mm depth with a 72 l/m flow rate.



### 105mm (End Parallel Outlet)

PurusLivinglineardrainwithahorizontalendparalleloutlet. GravitywastewithasprungNoodtrap,anoodourwaste. 105mm depth with a 72 l/m flow rate.

## Description

Maxxus has a new deck with an adapted PurusLiving linear channel drain for wet rooms with a microcement or resin floor finish. Black brushed aluminum grate that creates a 3mm upstand.

Available in a range of sizes, the Purus gully outlet can be either low side, side or end parallel

Key benefits:

- Formicrocementandresin flooring
- Material Tanking Collar
- Suitable for timber and concrete floors Strong
- and durable base yet only 22mm thick Vacuum
- formed GRP
- Made from 50% recycled materials and is 100% recyclable Solid
- right through - no pockets or hollow cavities
- Creates a level access floor with no step
- Built in gradients for water removal to the waste
- Accepts 470kg (75 stone) loading over 400mm joist centres
- Self-supporting - no requirement for additional support underneath
- Removable sprung NOOD water trap

- The NOOD no-odour water trap which will not allow any foul air to escape even if the gully dries out
- Black brushed aluminium grid that creates a 3mm upstand
- Choice of size

### **Installation:**

- May be trimmed down to any size
- Fast 1 hour install - laid straight on joists no under boarding needed
- Totally flat underside and recessed screw holes allow for easy fixing
- No release agent to inhibit bonding of the micro cement and resin floor finish

### **Includes Purus Living Linear drain with three outlet types with Purus NOOD traps:**

- 600mm or 800mm lengths depending on the floor former size
- Plastic-bodied unit
- Choice of three gully outlets each with a ABS pipe reducer 2" to 1½" (50mm to 40mm):
  - - Low Side Outlet up to 32 ltr/min flow rate - depth (mm): 52
  - - End Parallel Outlet up to 72 ltr/min flow rate - depth (mm): 105
  - - Side Outlet up to 72 ltr/min flow rate - depth (mm): 105
- Please select above
- Note: Download PDF installation instructions for more information

### **Grid technical detail:**

- Adaptor grid for Purus Living Linear drain for use with micro cement or resin floor finishes
- Manufactured from high grade anodised aluminium with a black finish
- Creates a 3mm upstand
- Designed and manufactured by Wetroom Innovations Ltd

### **Warranty:**

- Maxxus floor formers come with a 25-year manufacturer guarantee

### **Please note:**

- The Micro Cement / Resin flooring materials and tanking kit are not included

## Additional Information

---

<b>Manufacturer</b>	<b>Maxxus</b>
<b>Size (mm)</b>	<b>1200x900, 1200x1200, 1400x900, 1500x900, 1600x900</b>
<b>Floor Former Thickness (mm)</b>	<b>22</b>
<b>Waste Options</b>	<b>Purus Linear 105mm End Parallel Outlet, Purus Linear 105mm Low Side Outlet, Purus Linear 52mm Low Side Outlet</b>
<b>For Floor Finish</b>	<b>Micro Cement, Resin Floors</b>
<b>Flow Rate / l/min</b>	<b>32,72</b>